

01. accessos

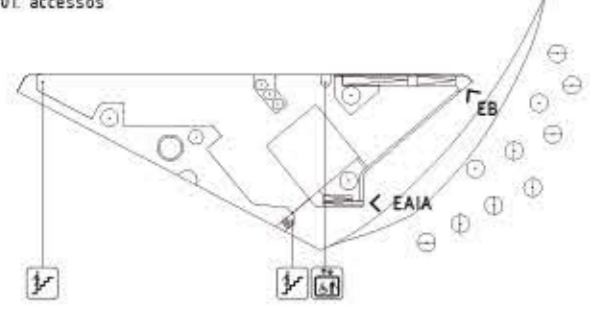

02. entorn proper

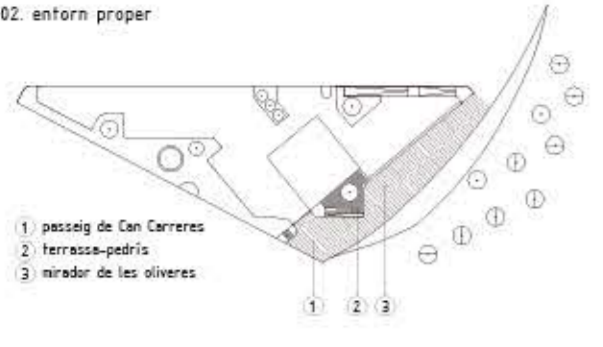

03. fluïdesa espacial

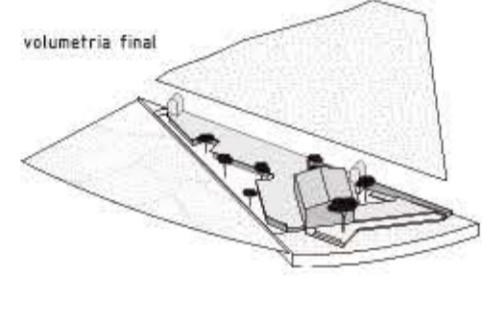
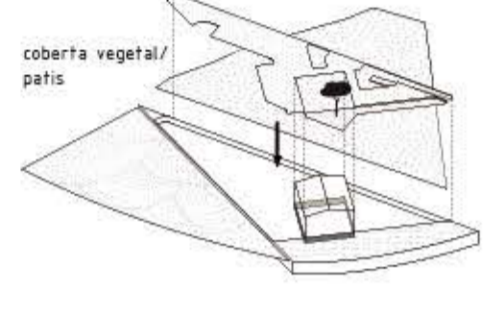
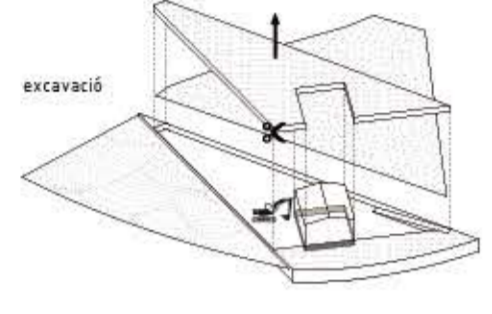
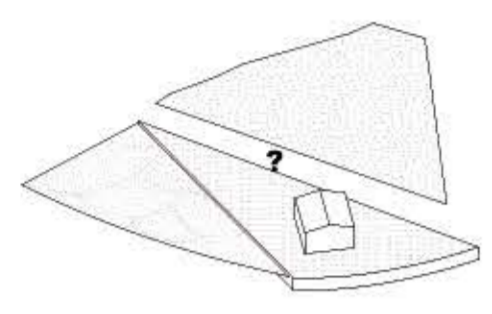
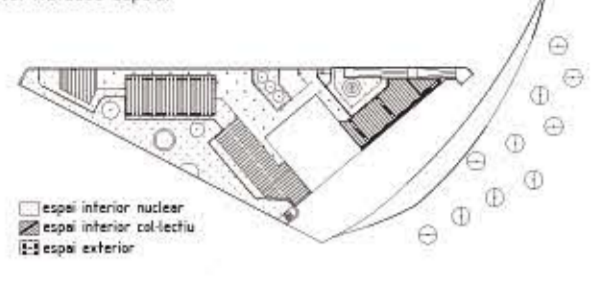

LLEGENDA

	sup. útil
1. Jardí	392,00 m ²
2. Guarda-cotxes	24,00 m ²
3. Direcció	16,00 m ²
4. Sala professors	29,50 m ²
5. Lavabo adaptat	6,50 m ²
6. Vestuari	18,40 m ²
7. Traster	12,00 m ²
8. Instal·lacions	18,00 m ²
9. Magatzem material escolar	7,50 m ²
10. Taller + visites	28,00 m ²
11. Sala usos múltiples	100,00 m ²
12. Aula 0/1 anys	43,00 m ²
13. Aules 1/2 anys	14,90 m ²
14. Aules 2/3 anys	120,00 m ²
15. Magatzem pati	4,00 m ²
16. Cuna i rebost	45,00 m ²
17. Escombreries	5,00 m ²
18. Menjador	24,00 m ²
19. Bugaderia	10,00 m ²
superfície construïda edifici	941,00 m ²

